

ON-OFF Valve Kit, 15GPM Normally Closed

9504616

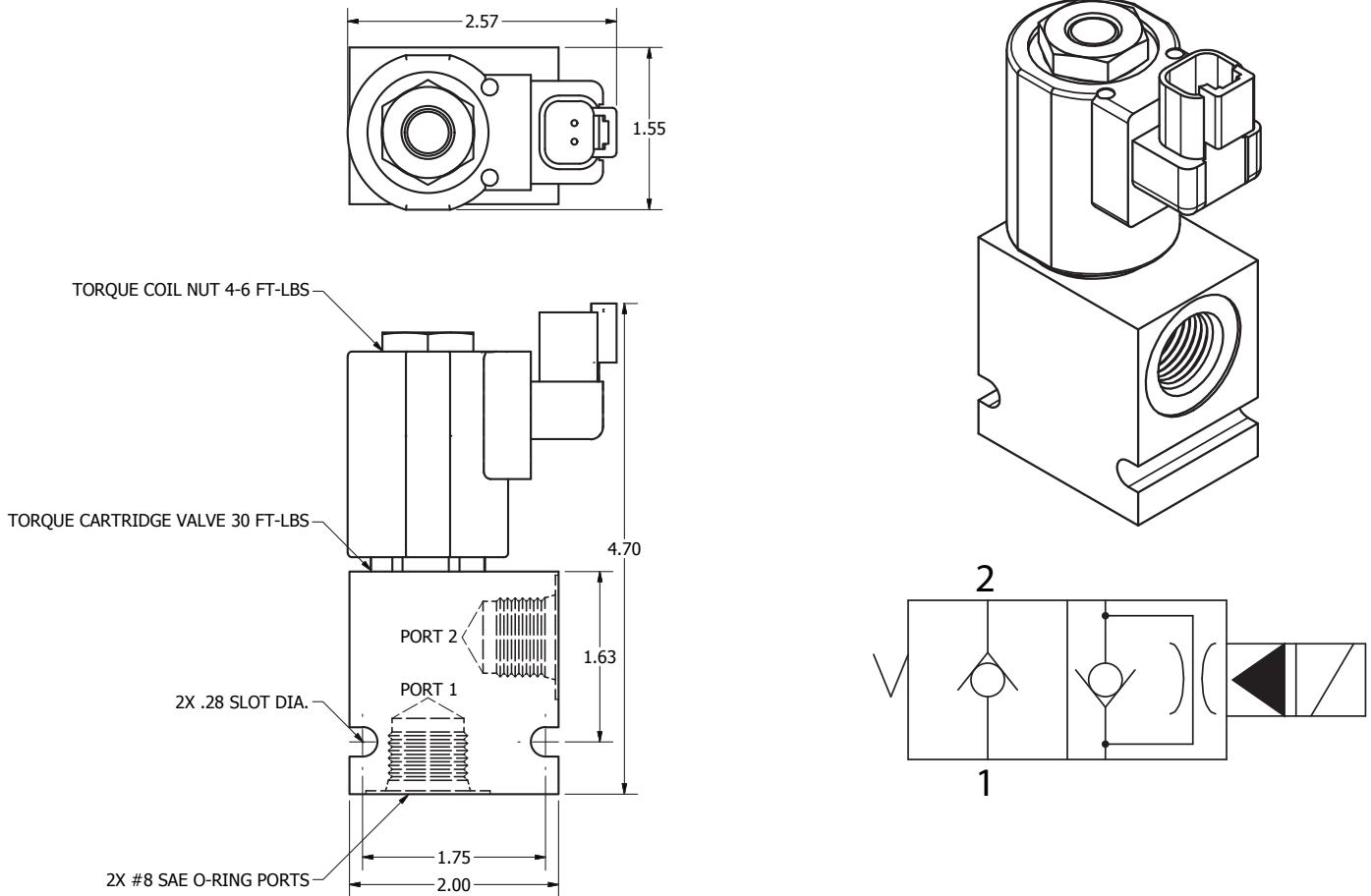

Technical Information



Normally Closed: When de-energized the valve blocks flow from (1) to (2) and allows reverse flow from (2) to (1). When energized the valve allows flow from (1) to (2) and restricts flow from (2) to (1).

- Flow: 15 GPM
- Pressure: 3500 PSI
- Typical Internal Leakage: 0-5 drops/min
- Temperature Range: -40°F to +250°F
- Ports: #8 SAE O-Ring
- Voltage: 12 VDC
- Amperage: 2.0 Amps
- Nominal Wattage: 24 Watts
- Duty Rating: Continuous
- 2-Way/2-Position Valve
- Aluminum Body
- Anodized Black
- DT04-2P Deutsch termination
- Weatherproof Coil
- Immersion Proof
- Thermal Shock/Dunk Tested
- No External Metal Shell

