

DF-PCT ADJUSTABLE PRESSURE COMPENSATING VALVE, RESTRICTIVE TYPE

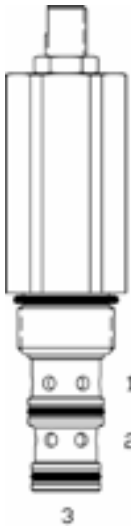

DESCRIPTION

10 size, 7/8-14 thread, "Delta" series, pressure compensating valve, restrictive type.

OPERATION

The DF-PCT with an external orifice in front of port (1) allows pressure compensated flow from (1) to (2), regulated by the pressure present at (3). The spring chamber is constantly vented at (1).

FEATURES

- Hardened parts for long life.
- Industry common cavity.

HYDRAULIC SYMBOL

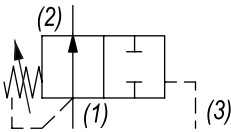

Can be used as an adjustable logic element. For fixed version see DF-PCS. For higher spring differential pressure ranges consult factory.

PERFORMANCE

Actual Test Data (Cartridge Only)

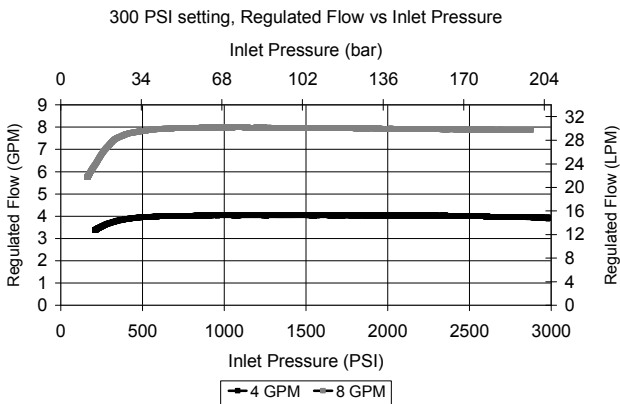

VALVE SPECIFICATIONS

| | |
|------------------------------------|----------------------------------|
| Nominal Flow | 10 GPM (38 LPM) |
| Rated Operating Pressure | 3500 PSI (241 bar) |
| Typical Internal Leakage (150 SSU) | 5 cu in/min (82 ml/min) per path |
| Viscosity Range | 36 to 3000 SSU (3 to 647 cSt) |
| Filtration | ISO 18/16/13 |
| Media Operating Temp. Range | -40° to 250°F (-40° to 120°C) |
| Weight | .60 lbs (.27 kg) |
| Operating Fluid Media | General Purpose Hydraulic Fluid |
| Cartridge Torque Requirements | 30 ft-lbs (40.6 Nm) |
| Cavity | DELTA 3W |
| Cavity Form Tool (Finishing) | 40500001 |
| Seal Kit | 21191210 |

WARNING: the specifications/application data shown in our catalogs and data sheets are intended only as a general guide for the product described (herein). Any specific application should not be undertaken without independent study, evaluation, and testing for suitability.



4484 Boeing Drive Rockford, IL 61109 • USA • Phone +1 (815) 397-6628 • Fax +1 (815) 397-2526
 mail: delta@delta-power.com • www.delta-power.com



Via Malavolti, 36 • 41122 Modena • ITALY • Phone +39 (059) 254895 • Fax +39 (059) 253512
 mail: tecnord@tecnord.com • www.tecnord.com

DIMENSIONS

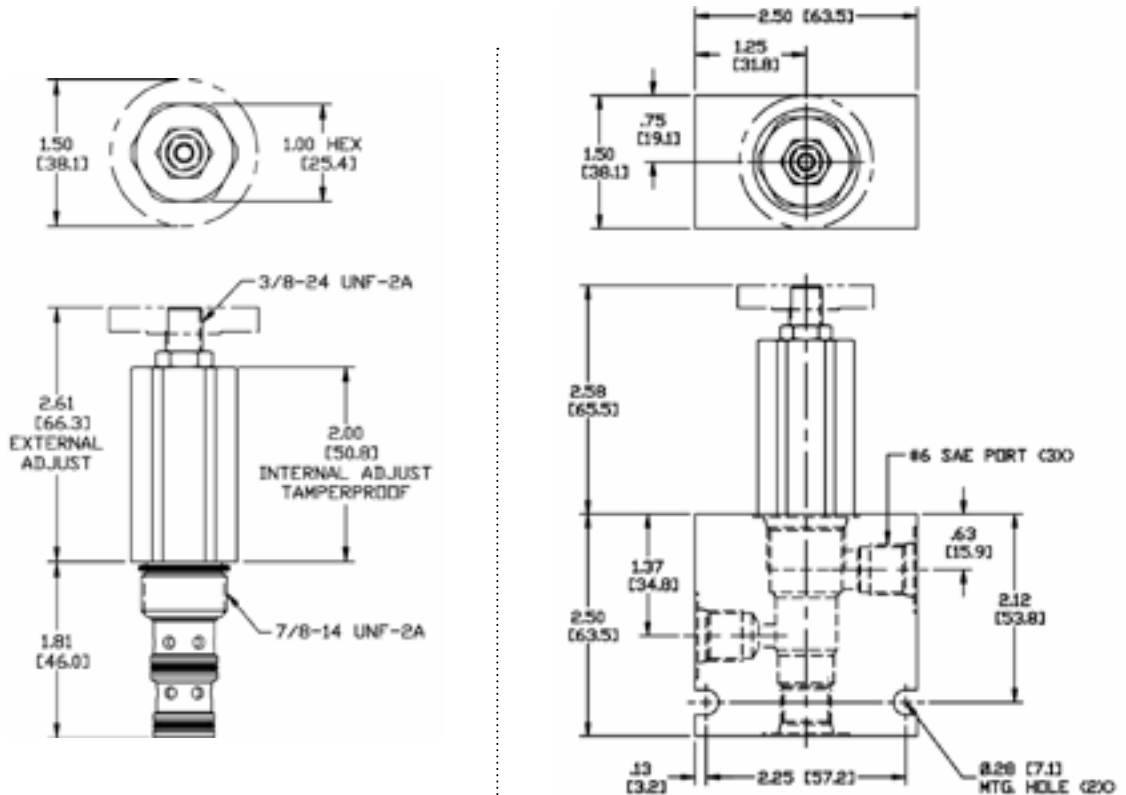

Body Weight: .76 lbs (.35 kg)

ORDERING INFORMATION

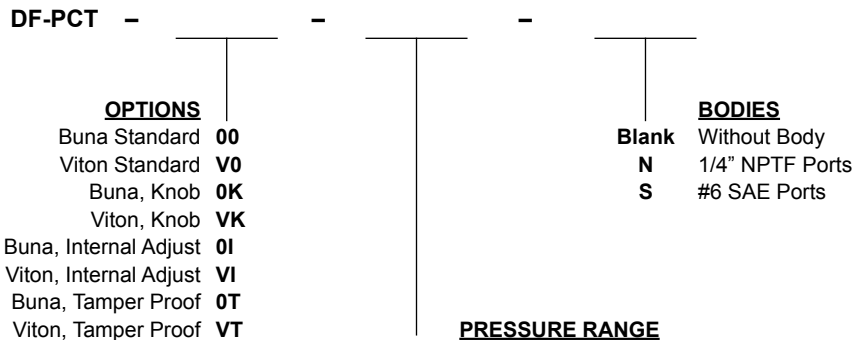

PRESSURE RANGE
0300 50 - 300 PSI

Differential Pressure Across
External Controlling Orifice

Tamper Proof
Fill in 4 Digit Pressure Setting
Example: 0200 - 200 PSI

W 6 / 2020

WARNING: the specifications/application data shown in our catalogs and data sheets are intended only as a general guide for the product described (herein). Any specific application should not be undertaken without independent study, evaluation, and testing for suitability.



4484 Boeing Drive Rockford, IL 61109 • USA • Phone +1 (815) 397-6628 • Fax +1 (815) 397-2526
mail: delta@delta-power.com • www.delta-power.com



Via Malavolti, 36 • 41122 Modena • ITALY • Phone +39 (059) 254895 • Fax +39 (059) 253512
mail: tecnord@tecnord.com • www.tecnord.com