

PP-PCC FIXED PRESSURE COMPENSATING REGULATOR VALVE - RESTRICTIVE TYPE



DESCRIPTION

8 size, 3/4-16 thread, "Power" series, pressure compensating regulator valve (restrictive type).

OPERATION

The PP-PCC-00 with an external orifice beyond port (3) and sensed by port (1) maintains a constant flow rate from (3) regardless of load pressure changes in the system downstream of (3), or in the inlet at (2) as long as pressure at (3) is above (1) by more than spring setting chosen and pump supply is in excess of demand. The valve's spool maintains a constant differential pressure across an external orifice, thereby regulating the hydraulic flow rate across this external orifice (see options table for pressure ranges). When used with an orifice as described above, it functions as a restrictive type regulator, delivering pump flow through the external orifice. All ports may be fully pressurized.

FEATURES

- Hardened parts for long life.
- Industry common cavity.

HYDRAULIC SYMBOL

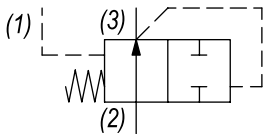

Can be used as a logic element. Fixed setting pressure reducing valve. For adjustable setting see PP-PCD. PP-PCC-00-0100 is recommended for regulated flows up to 4.0 GPM only. PP-PCC-00-0220 is recommended for regulated flows up to 8.0 GPM. For fixed pressure reducing/relieving valve see PP-PCP.

PERFORMANCE

Actual Test Data (Cartridge Only)

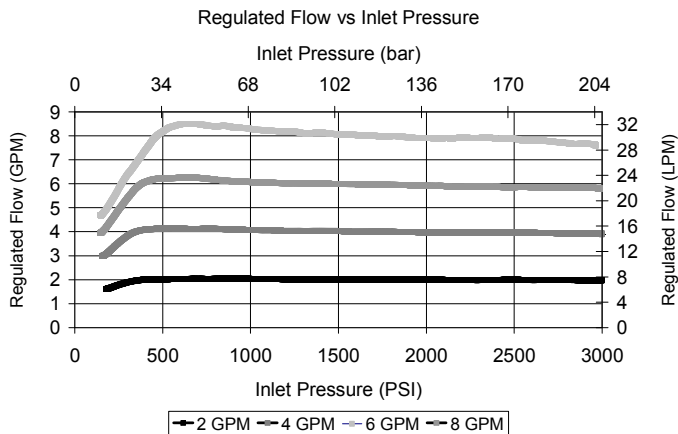

VALVE SPECIFICATIONS

Nominal Flow	8 GPM (30 LPM)
Rated Operating Pressure	3000 PSI (207 bar)
Ratio	Area of Pilot is equal to the area at Port (3)
Viscosity Range	36 to 3000 SSU (3 to 647 cSt)
Filtration	ISO 18/16/13
Media Operating Temp. Range	-40° to 250°F (-40° to 120°C)
Weight	.25 lbs (.11 kg)
Operating Fluid Media	General Purpose Hydraulic Fluid
Cartridge Torque Requirements	25 ft-lbs (34 Nm)
Cavity	POWER 3W
Cavity Form Tool (Finishing)	40500024
Seal Kit	21191111

WARNING: the specifications/application data shown in our catalogs and data sheets are intended only as a general guide for the product described (herein). Any specific application should not be undertaken without independent study, evaluation, and testing for suitability.



4484 Boeing Drive Rockford, IL 61109 • USA • Phone +1 (815) 397-6628 • Fax +1 (815) 397-2526
 mail: delta@delta-power.com • www.delta-power.com



Via Malavolti, 36 • 41122 Modena • ITALY • Phone +39 (059) 254895 • Fax +39 (059) 253512
 mail: tecnord@tecnord.com • www.tecnord.com

DIMENSIONS

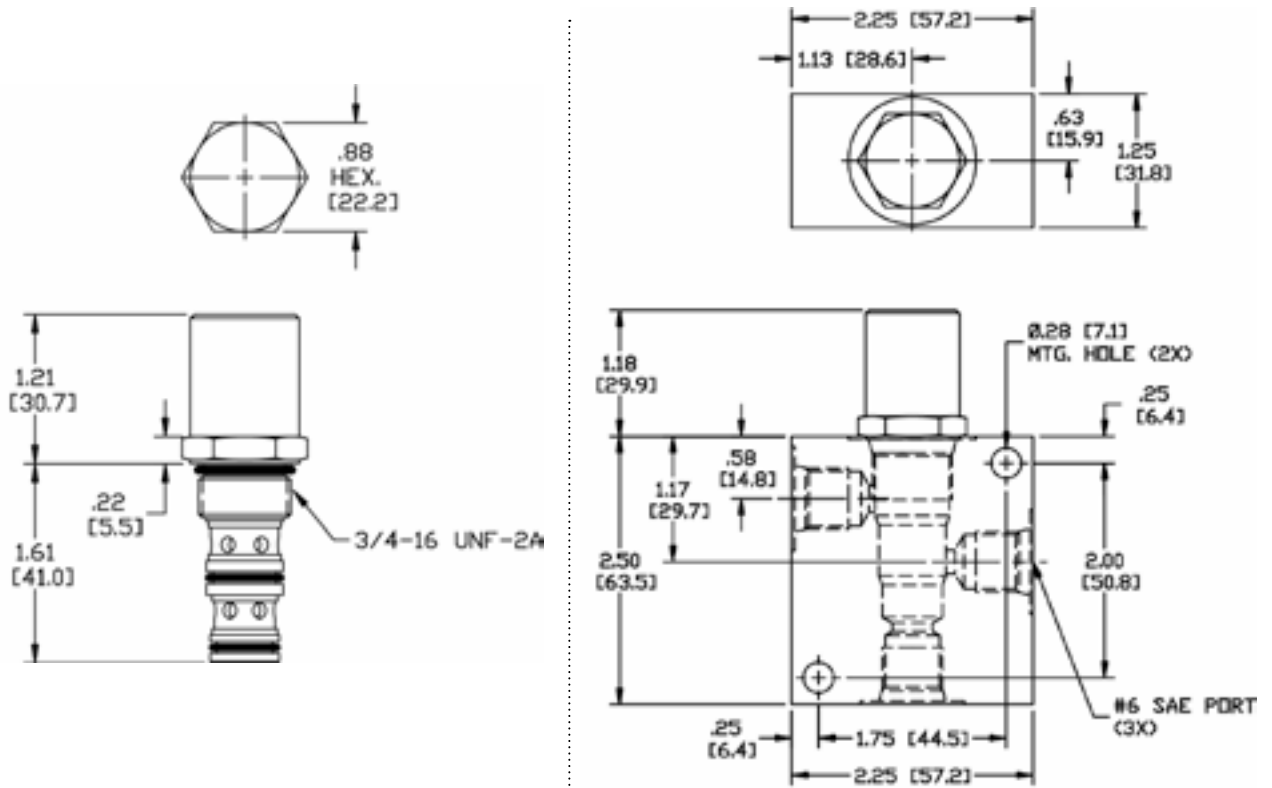

Body Weight: .56 lbs (.25 kg)

ORDERING INFORMATION

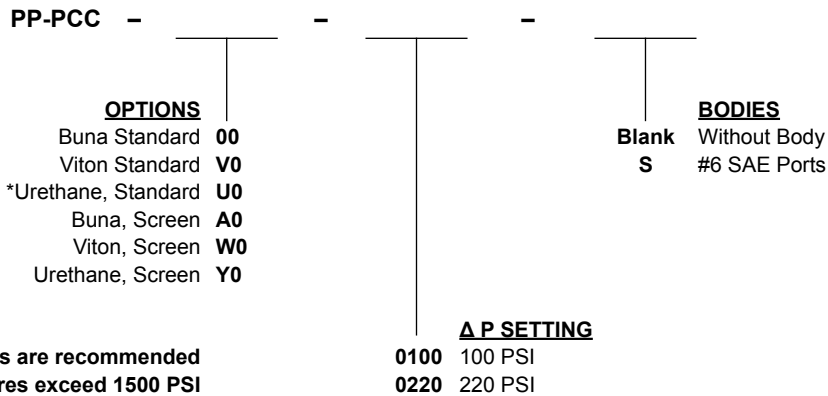

*Urethane seals are recommended when inlet pressures exceed 1500 PSI

W 6 / 2020

WARNING: the specifications/application data shown in our catalogs and data sheets are intended only as a general guide for the product described (herein). Any specific application should not be undertaken without independent study, evaluation, and testing for suitability.



4484 Boeing Drive Rockford, IL 61109 • USA • Phone +1 (815) 397-6628 • Fax +1 (815) 397-2526
 mail: delta@delta-power.com • www.delta-power.com



Via Malavolti, 36 • 41122 Modena • ITALY • Phone +39 (059) 254895 • Fax +39 (059) 253512
 mail: tecnord@tecnord.com • www.tecnord.com