

SK-PRP PILOT OPERATED PRESSURE REDUCING, RELIEVING VALVE

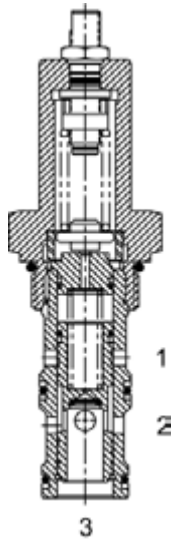

DESCRIPTION

16 size, 1 5/16-12 thread, "Super" series, pilot operated pressure reducing, relieving valve.

OPERATION

The SK-PRP in its steady state, allows flow to pass from (2) to (3), with the spring chamber constantly drained at (1). When a pre-determined pressure is reached at (3), the spool shifts to restrict input flow at (2), thereby reducing (restricting) flow. If the valve and pressure at port (3) exceeds setting, spool shifts to open passage at port (1), thereby regulating pressure at (3) by relieving excess flow. The cartridge offers smooth transition in response to load changes in common hydraulic circuits.

FEATURES

- Hardened parts for long life.
- Industry common cavity.

HYDRAULIC SYMBOL

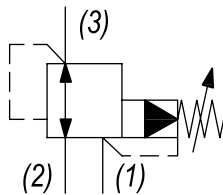

PERFORMANCE

Actual Test Data (Cartridge Only)

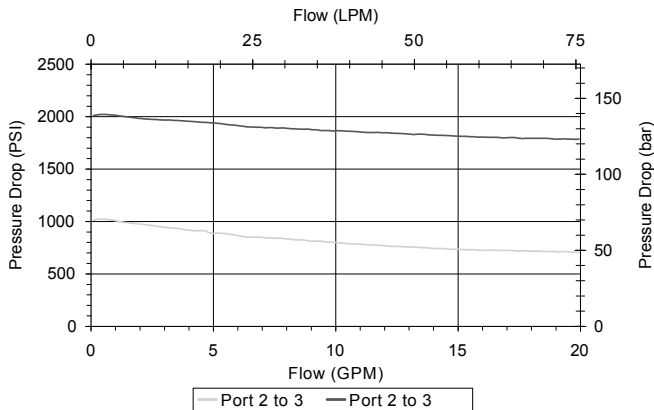

VALVE SPECIFICATIONS

Nominal Flow	20 GPM (76 LPM)
Rated Operating Pressure	500-3000 PSI (34-207 bar)
Viscosity Range	36 to 3000 SSU (3 to 647 cSt)
Filtration	ISO 18/16/13
Media Operating Temp. Range	-40° to 250°F (-40° to 120°C)
Weight	1.28 lbs (.58 kg)
Operating Fluid Media	General Purpose Hydraulic Fluid
Cartridge Torque Requirements	90 ft-lbs (122 Nm)
Cavity	SUPER 3W
Cavity Form Tool (Finishing)	40500018
Seal Kit	21191406

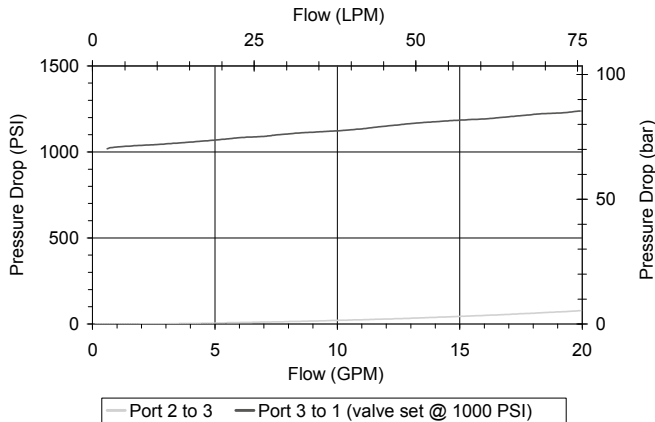

WARNING: the specifications/application data shown in our catalogs and data sheets are intended only as a general guide for the product described (herein). Any specific application should not be undertaken without independent study, evaluation, and testing for suitability.



4484 Boeing Drive Rockford, IL 61109 • USA • Phone +1 (815) 397-6628 • Fax +1 (815) 397-2526
 mail: delta@delta-power.com • www.delta-power.com



Via Malavolti, 36 • 41122 Modena • ITALY • Phone +39 (059) 254895 • Fax +39 (059) 253512
 mail: tecnord@tecnord.com • www.tecnord.com

DIMENSIONS

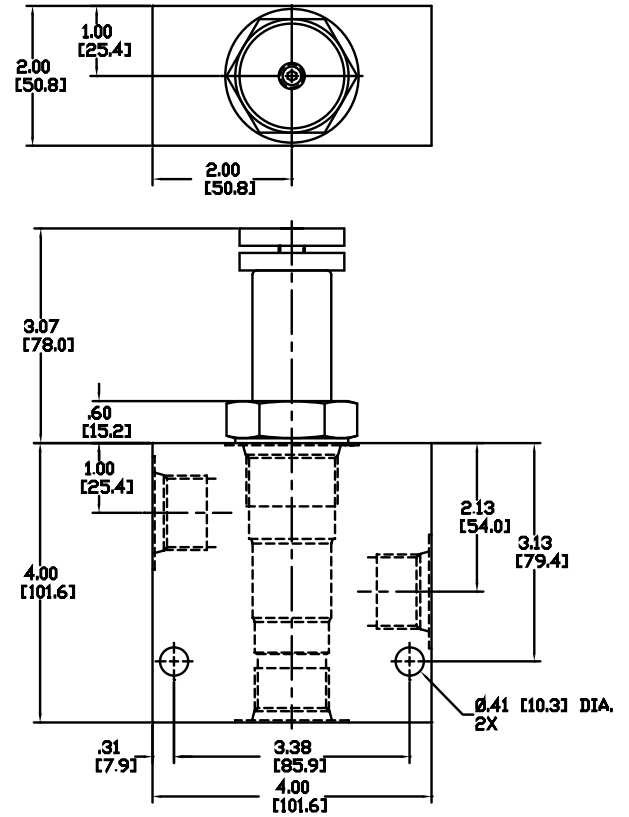
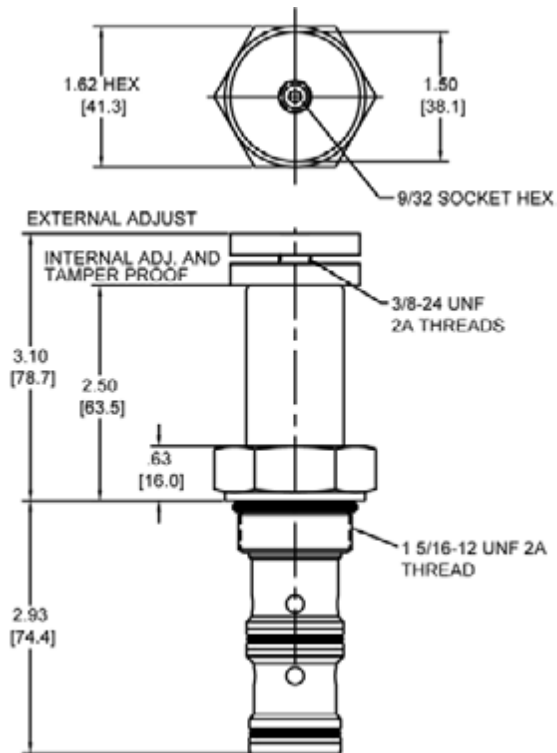

Body Weight: 2.46 lbs (1.11 kg)

ORDERING INFORMATION

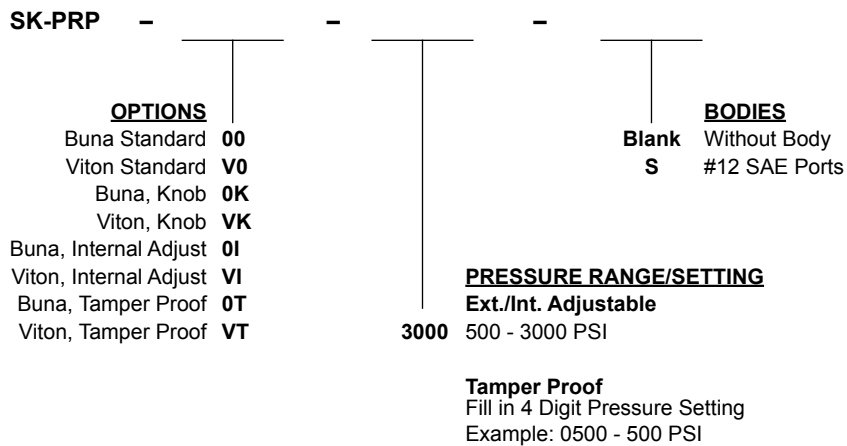

W7/2017

WARNING: the specifications/application data shown in our catalogs and data sheets are intended only as a general guide for the product described (herein). Any specific application should not be undertaken without independent study, evaluation, and testing for suitability.



4484 Boeing Drive Rockford, IL 61109 • USA • Phone +1 (815) 397-6628 • Fax +1 (815) 397-2526
mail: delta@delta-power.com • www.delta-power.com



Via Malavolti, 36 • 41122 Modena • ITALY • Phone +39 (059) 254895 • Fax +39 (059) 253512
mail: tecnord@tecnord.com • www.tecnord.com