

**DG-S4A DIRECT ACTING SPOOL, 4 WAY 2 POSITION**

**DESCRIPTION**

10 size, 7/8-14 thread, "Delta" series, solenoid operated, 4 way 2 position, side flow spool valve.

**OPERATION**

When de-energized the DG-S4A allows flow between (1) to (4) and (2) to (3). When energized the valve allows flow between (2) to (1) and (3) to (4).

**OPERATION OF MANUAL OVERRIDE OPTION:** to override, pull knob out. On the detented version, after pulling knob out twist 180 degrees and release. The valve will remain in that position..

**FEATURES**

- Hardened parts for long life.
- Efficient wet-armature construction.
- Cartridges are voltage interchangeable.
- Manual override option.
- Industry common cavity.
- Unitized, molded coil design.
- Continuous duty rated solenoid.
- Optional coil voltages and terminations.
- Optional "I" Coil: Weatherproof, Thermal Shock, Immersion Safe.



For higher pressures see HG-S4A.

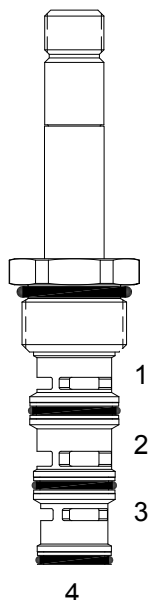

**PERFORMANCE**

Actual Test Data (Cartridge Only)

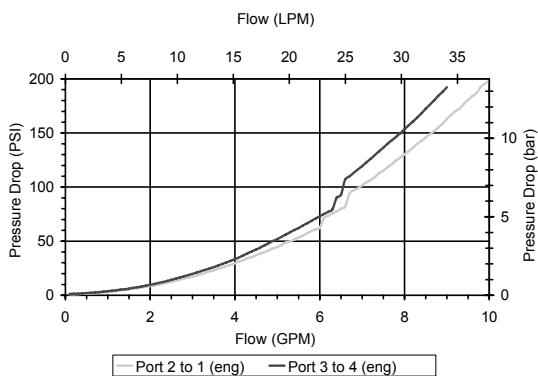
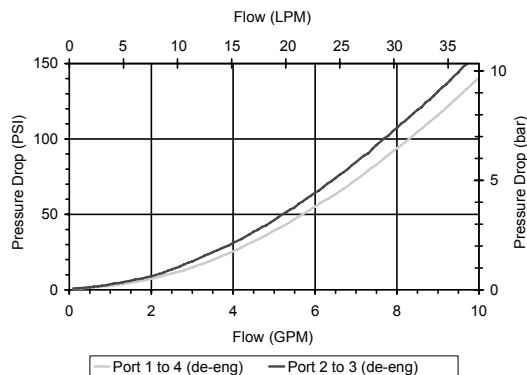

**HYDRAULIC SYMBOL**

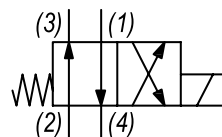

**VALVE SPECIFICATIONS**

Nominal Flow	10 GPM (38 LPM)
Rated Operating Pressure	3500 PSI (241 bar) per path
Typical Internal Leakage (150 SSU)	5 cu in/min (82 ml/min)
Viscosity Range	36 to 3000 SSU (3 to 647 cSt)
Filtration	ISO 18/16/13
Media Operating Temp. Range	-40° to 250°F (-40° to 120°C)
Weight	.32 lbs (.15 kg)
Operating Fluid Media	General Purpose Hydraulic Fluid
Cartridge Torque Requirements	30 ft-lbs (40.6 Nm)
Coil Nut Torque Requirements	4-6 ft-lbs (5.4-8.1 Nm)
Cavity	DELTA 4W
Cavity Tools Kit	
(form tool, reamer, tap)	40500002
Seal Kit	21191214

**WARNING:** the specifications/application data shown in our catalogs and data sheets are intended only as a general guide for the product described (herein). Any specific application should not be undertaken without independent study, evaluation, and testing for suitability.



4484 Boeing Drive Rockford, IL 61109 • USA • Phone +1 (815) 397-6628 • Fax +1 (815) 397-2526  
 mail: delta@delta-power.com • www.delta-power.com



Via Malavolti, 36 • 41122 Modena • ITALY • Phone +39 (059) 254895 • Fax +39 (059) 253512  
 mail: tecnord@tecnord.com • www.tecnord.com

# SOLENOID OPERATED DIRECTIONAL CONTROLS

## DIMENSIONS

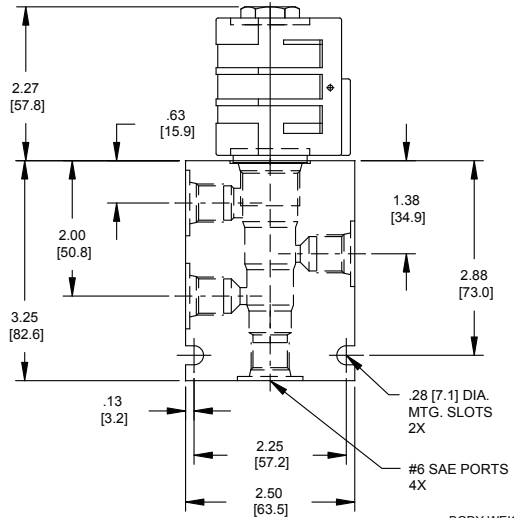
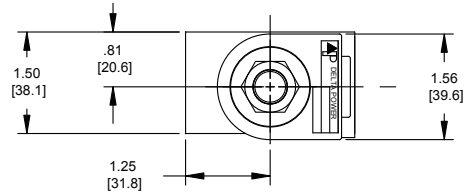
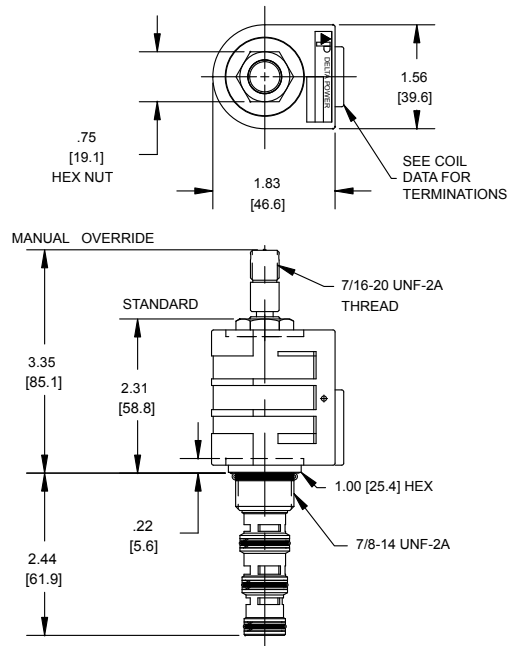

BODY WEIGHT: .99 lbs (.45 kg)

## ORDERING INFORMATION

Approximate Coil Weight: .74 lbs (.33 kg)

### DG-S4A

- OPTIONS**
- Buna Standard **00**
  - Viton Standard **V0**
  - Buna, Override, Detent **0M**
  - Viton, Override, Detent **VM**
  - Buna, Override, Non-detent **B1**
  - Viton, Override, Non-detent **V1**

- BODIES**
- Blank Without Body
  - N** 1/4 NPTF Ports
  - S** #6 SAE Ports

- VOLTAGE**
- 06** 6 VDC
  - 12** 12 VDC
  - 24** 24 VDC
  - 36** 36 VDC
  - 48** 48 VDC
  - 25** 24 VAC
  - 11** 120 VAC
  - 22** 220 VAC
  - 44** 440 VAC

**"D" COIL TERMINATION**  
(All DC Except as Noted)

- DL** Double Lead
- DT** Deutsch on Leads DT04-2P
- ML** Metri-Pack on Leads
- PL** Packard on Leads
- WL** Weatherpack on Leads

- SS** Single Spade
- DS** Double Spade
- HC** DIN 43650 (Hirschmann) - (AC&DC)
- CL** Conduit Lead - (AC Only)
- DI** Deutsch - Integral DT04-2P

- IMMERSION PROOF "D" TYPE**
- IA** "I" Coil AMP Superseal - Integral
  - ID** "I" Coil - Deutsch - Integral DT04-2P
  - IJ** "I" Coil AMP Jr. Timer - Integral
  - IM** "I" Coil - Metri-Pack - Integral

W 26 / 2019

**WARNING:** the specifications/application data shown in our catalogs and data sheets are intended only as a general guide for the product described (herein). Any specific application should not be undertaken without independent study, evaluation, and testing for suitability.



4484 Boeing Drive Rockford, IL 61109 • USA • Phone +1 (815) 397-6628 • Fax +1 (815) 397-2526  
mail: delta@delta-power.com • www.delta-power.com



Via Malavolti, 36 • 41122 Modena • ITALY • Phone +39 (059) 254895 • Fax +39 (059) 253512  
mail: tecnord@tecnord.com • www.tecnord.com