

3/2-way solenoid valve, G1/4, monostable - Mod. 334... Mod 344...

These solenoid valves, which have electropneumatic actuation and spring return, are available in the NC (closed) or NO (open) version.

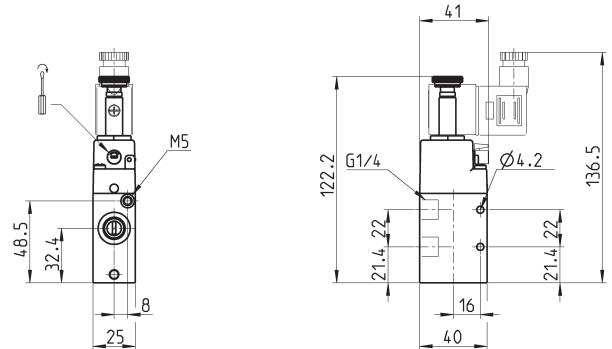
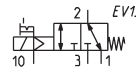
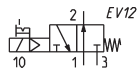
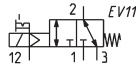
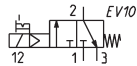

Mod.	Mounting	Function	Flow rate (Nl/min)	Operating pressure (bar)	Pilot pressure (bar)	Symbol
334-015-02	in-line	3/2 NC	1300	2.5 ÷ 10	-	EV10

Solenoids for Mod. U70/ / U7*EX / G70 (EN 175301-803 Form B Industrial)

The U7* series of solenoid coils complies with both standards UL and CSA, and the marking we will apply on the solenoids is cURus (standards UL 429 and CSA 22.2 n. 139).

The U7* coil series is also available in an ATEX explosion rated version. Mod. U7*EX is marked II 3 GD Eex nA T4.

NOTE: to order the ATEX version of the U7* coil it is necessary to add the EX suffix at the end of the code.

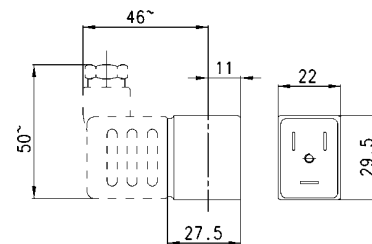
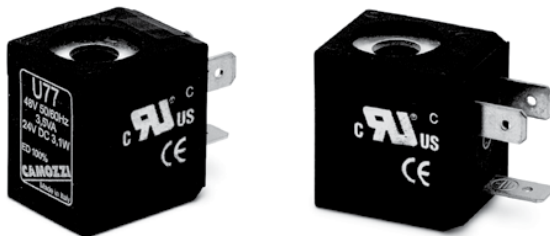

Nominal dimensions:	22x22
Protection class:	IP54 - DIN 40050 IP65 (with connector Mod. 122-800)
Insulation:	Class H (180°C)
Connections:	Bipolar plus earth DIN 43650 (version B)
Voltage tolerance:	AC +10% - 15% DC ±10%
Continuous operation:	ED 100%
Protection:	U70 PET G70 Nylon

Solenoid Voltages U70 (UL and CSA approved)

Mod.				Mod.			
U7H	24V	50/60 Hz	3,5VA	U77	24V	DC	3,1W
	12V	DC	3,1W		48V	50/60 Hz	3,5VA
U7K	110V	AC 50/60 Hz	4,3VA				
	125V	AC 50/60 Hz	5,5VA				

Dimensions in millimeters (mm)

MANUAL OVERRIDE

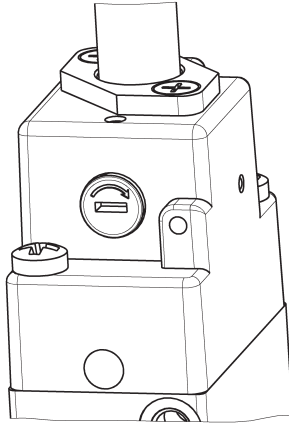

Example of solenoid valve with a bistable standard manual override.

GENERAL DATA

Construction	spool - type
Valve group	2x3/2 - 3/2 - 5/2 - 5/3-way CC CO CP
Materials	AL body, stainless steel spool, NBR seals
Ports	G1/8 - G1/4
Installation	in any position
Operating temperature	0 ÷ 60°C (with dry air at -20°C)
Operating pressure	see tables
Fluid	filtered air, without lubrication. If lubricated air is used, it is recommended to use ISOVG32 oil. Once applied the lubrication should never be interrupted.

CODING EXAMPLE

3	3	8	D	-	015	-	02	-	U7	7
----------	----------	----------	----------	----------	------------	----------	-----------	----------	-----------	----------

3	SERIES
3	NUMBER OF WAYS - POSITIONS: 3 = 3/2 NC 4 = 3/2 NO 5 = 5/2 6 = 5/3 CC 7 = 5/3 CO 8 = 5/3 CP 9 = 1x3/2 NC + 1x3/2 NO
8	PORTS: 8 = G1/8 4 = G1/4
D	VERSION: = standard D = double valve 2x3/2 L = for manifold assembly (only for solenoid valves 3/2 with G1/8 ports)
015	ACTUATION: 011 = double solenoid 015 = single solenoid, spring return 016 = single solenoid, pneumatic spring return E11 = double solenoid external servo-command E15 = single solenoid, external servo-command 033 = pneumatic pneumatic 035 = pneumatic spring
22	SOLENOID INTERFACE: 02 = mech. sol. 22 x 22
U7	ENCAPSULATING MATERIAL / SOLENOID DIMENSIONS: A8 = PPS / 30 x 30 G7 = PA / 22 x 22 G8 = PA / 30 x 30 (24 V DC only) G9 = PA / 22 x 58 H8 = PA 6 V0 / 30 x 30 U7 = PET / 22 x 22
7	SOLENOID VOLTAGE: see the solenoids section from page 2.2.35.01
	TYPE OF MANUAL OVERRIDE: = bistable, standard IL = bistable, lever type (available on demand) IM = monostable (available on demand)