

# MODEL DS DOUBLE SELECTOR VALVE

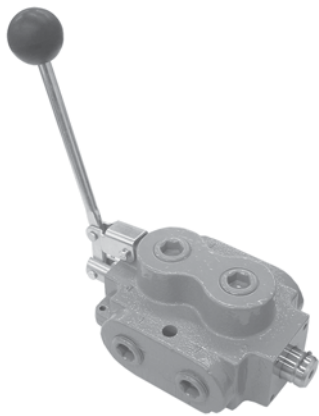

The PRINCE valve model DS is a manual 6-way 2 position double selector valve. This valve will divert the flow going to two separate hydraulic circuits. For example two double acting cylinders or two reversible hydraulic motors can be operated by one four-way valve. When the double selector spool is pushed in, the C and D ports (top ports) are connected to the A and E ports (right ports). When the selector spool is pulled out, the C and D ports are connected to the B and F ports (left ports). An optional series/parallel spool is also available. This spool will run two reversible hydraulic motors in series when the spool is out and in parallel when the spool is pushed in.

### VALVE SPECIFICATIONS:

Capacity: 40 GPM max inlet flow  
 Pressure: 2500 psi  
 Weight: 9 lbs.

### KITS:

LEVER HANDLE 660170001  
 SPRING OFFSET KIT 660170003  
 2 POSITION DETENT KIT 660170004  
 END CAP KIT 660170010  
 SEAL KIT 660590005  
 KNOB PART NO. 670400029  
 SNAP RING PART NO. 230017018  
 CLEVIS PART NO. 671400059

### STANDARD MODELS AVAILABLE

MODEL #	PORT SIZE	DESCRIPTION
DS-4A1E	3/4 NPTF	DOUBLE SELECTOR WITH LEVER HANDLE
DS-5A1E	#12 SAE	DOUBLE SELECTOR WITH LEVER HANDLE
DS-4A1D	3/4 NPTF	DOUBLE SELECTOR WITH KNOB HANDLE
DS-4A1A	3/4 NPTF	DOUBLE SELECTOR WITHOUT ATTACHMENTS
DS-1A1E	1/2 NPTF	DOUBLE SELECTOR WITH LEVER HANDLE

**SPECIAL MODEL DS SELECTOR VALVES** Other double selector valves not listed as standard are available in OEM quantities. To select a model number use the order code matrix below. Consult a sales representative if options other than those listed are required.

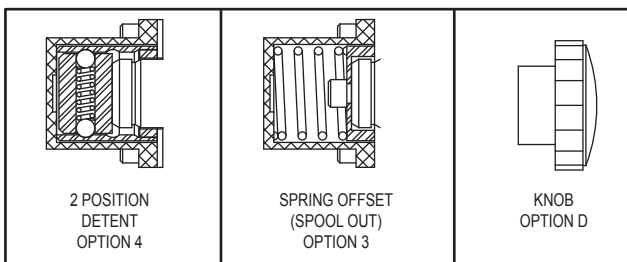

MODEL	PORT SIZE	SPOOL TYPE	SPOOL ATTACHMENTS	HANDLE
DS	1 - 1/2 NPTF 2 - #8 SAE 3 - #10 SAE 4 - 3/4 NPTF (standard) 5 - #12 SAE 6 - 1 NPTF	A SELECTOR (standard)  B SERIES/ PARALLEL	1 - NONE (standard) 2 - END CAP ONLY 3 - SPRING OFFSET SPOOL OUT 4 - 2 POSITION DETENT	A - NONE B - CLEVIS ONLY C - CLEVIS W/ PINS AND LINK D - KNOB E - LEVER HANDLE (standard) H - HYDRAULIC REQUIRES SPOOL ATTACHMENT 3

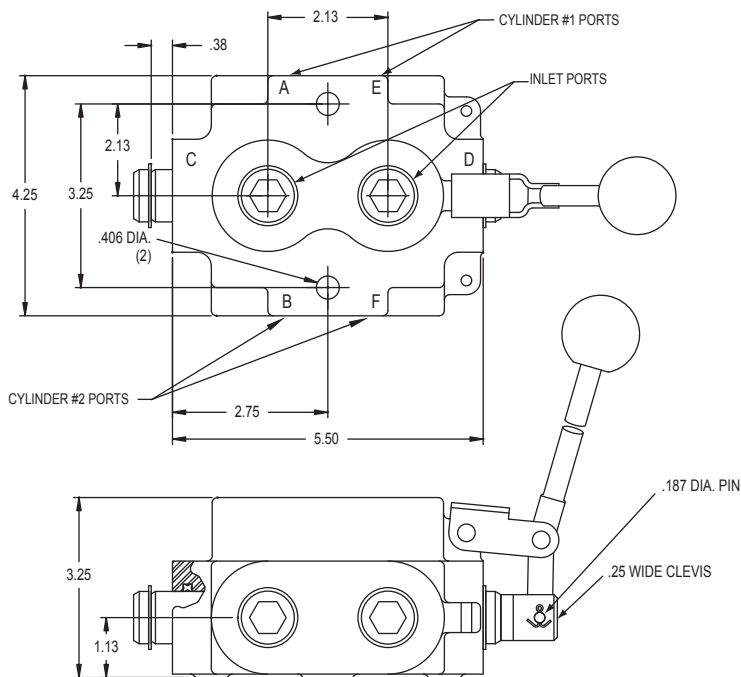

### SYMBOL SELECTOR SPOOL

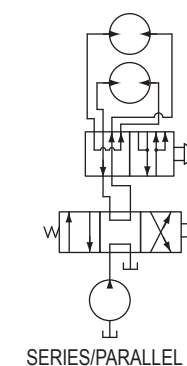
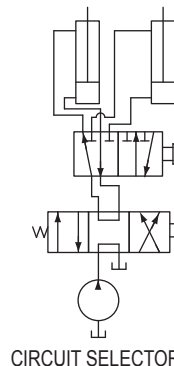
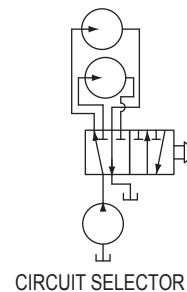
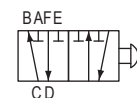

VALVES