

12 Male J.I.C. (37°) X Female J.I.C. (37°)

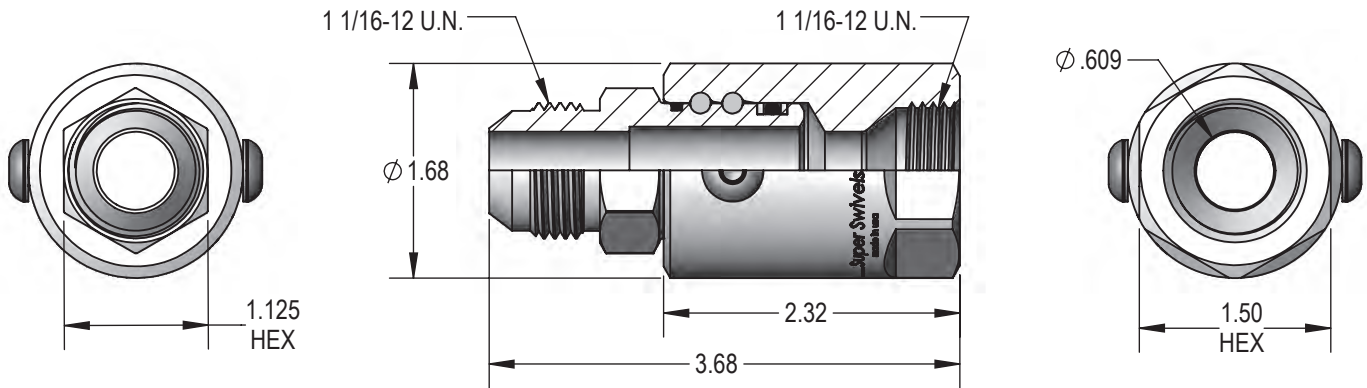

PART NUMBER
SS 12 DB MJ 12 X FJ 12

MAXIMUM P.S.I.G.
5,000

Not Available
In Stainless Steel!

*Extra Heavy Duty
Multiple Bearing Race*



For extreme duty applications **Extra Heavy Duty** swivel offer a multiple bearing race design for superior side load strength and added load bearing support.

The inner and outer race for the ball bearings is integrally designed and machined within tight tolerances into the hardened metal of the male stem and female body, providing a rigid track for the balls to roll freely, yet securely.

Extra Heavy Duty superior design, construction and seals allow for higher maximum pressure ratings than others, even in 90° configuration.

Multiple Bearing Race

