

# VENTED OIL GAGES

## G320 SERIES

The G320 Series vented brass oil gage has a large straight hex base with male pipe thread. A shield with machined viewing window surrounds the tubular glass sight. The viewing window has 360° adjustment for optimal orientation to view fluid after installation. The sealing gaskets are contained on both their ID and OD to facilitate trouble-free assembly after on-site repositioning of the viewing window.

### Standard Features:

- Gage base machined from brass hex bar stock
- Male tapered pipe thread base connection (3/8, 1/2 or 3/4 inch NPTF)
- .53 inch wide viewing window, length varies from 4.33 to 12.58 inches depending on gage selected
- 360° adjustment of viewing window
- Suitable for use with most machine lubricating oil

### Standard Materials:

- Brass construction
- Buna N seals
- Borosilicate glass sight

### Temperature Rating:

- Maximum operating temperature of 250°F (121°C) with standard Buna N seals. For applications not compatible with Buna N seal material, consult factory for available options and corresponding temperature ratings.

### Note:

- Oil Gage Modifications are available, please see Appendix LE-1 on page LE-A1 for more information.

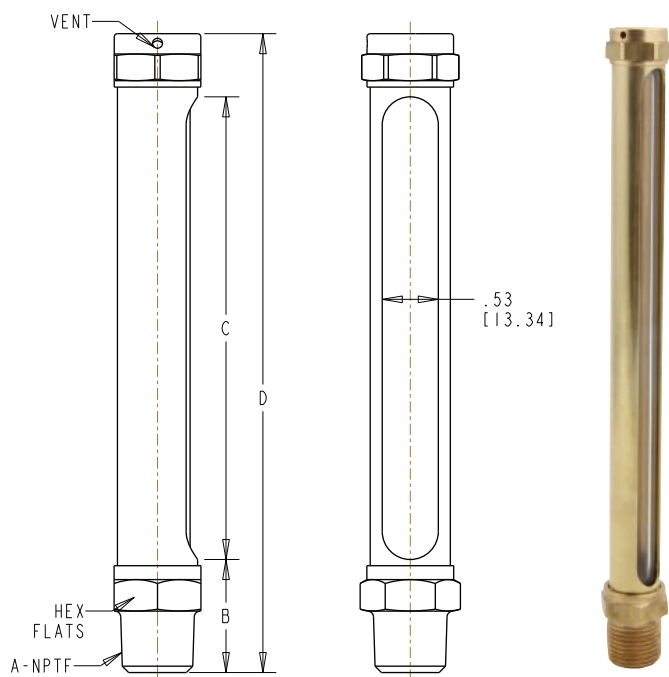

**NOTE:** All dimensions are inches [mm]

G320 Series					
Part No.	A NPTF	B inches (mm)	C inches (mm)	D inches (mm)	HEX FLATS
G321-3	3/8	1.16 (29.46)	4.33 (109.98)	6.00 (152.40)	.81 (20.57)
G321-4	1/2	1.35 (34.29)	4.33 (109.98)	6.19 (157.23)	.94 (23.88)
G322-3	3/8	1.16 (29.46)	5.58 (141.73)	7.25 (184.14)	.81 (20.57)
G322-4	1/2	1.35 (34.29)	5.58 (141.73)	7.44 (188.98)	.94 (23.88)
G322-5	3/4	1.35 (34.29)	5.58 (141.73)	7.44 (188.98)	1.06 (26.92)
G323-2	1/4	1.16 (29.46)	7.58 (192.53)	9.25 (234.95)	.81 (20.57)
G323-4	1/2	1.35 (34.29)	7.58 (192.53)	9.44 (239.78)	.94 (23.88)
G324-2	1/4	1.16 (29.46)	9.58 (243.33)	11.25 (285.75)	.81 (20.57)
G324-3	3/8	1.16 (29.46)	9.58 (243.33)	11.25 (285.75)	.81 (20.57)
G324-4	1/2	1.35 (34.29)	9.58 (243.33)	11.44 (290.58)	.94 (23.88)
G325-3	3/8	1.16 (29.46)	12.58 (319.53)	14.25 (361.95)	.81 (20.57)
G325-4	1/2	1.35 (34.29)	12.58 (319.53)	14.44 (366.78)	.94 (23.88)

Dimensions and specifications are subject to change without notice. Not all items are Made-To-Stock, contact us for availability.

02/14

Ph : 920-682-6877  
Fx : 920-684-7210



sales@ldi-industries.com  
www.ldi-industries.com

# APPENDIX LE-1

## OIL GAGE MODIFICATIONS

Modifications are specified below. Standard shield threads are 5/8-27 or 3/4-27. Minimum order quantity may be required.

### TOP CAP with MALE PIPE NPTF (dryseal)

- 1MP = 1/8 inch
- 2MP = 1/4 inch
- 3MP = 3/8 inch
- 4MP = 1/2 inch

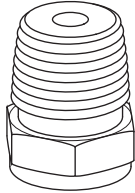

### TOP CAP with FEMALE PIPE NPTF (dryseal)

- 1FP = 1/8 inch
- 2FP = 1/4 inch
- 3FP = 3/8 inch

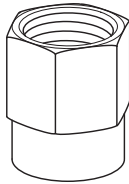

### TOP CAP with COMPRESSION FITTING STRAIGHT TUBE

- O.D. TUBE
- 1T = 1/8 inch
- 3T = 1/4 inch

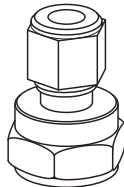

### TOP CAP with COMPRESSION FITTING 90° TUBE

- O.D. TUBE
- 3TA = 1/4 inch
- 4TA = 5/16 inch

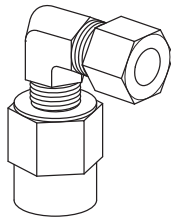

### TOP CAP with SNAP LID FILLER

-1FC

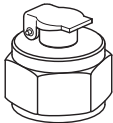

### TOP CAP with THREADED FILLER

-2FC

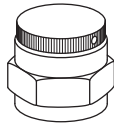

### TOP CAP, NON VENTED

-1NV

Up to 100 PSI

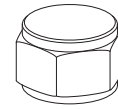

### TOP CAP with REPLACEABLE 40 MICRON FILTER VENT

-FV

Available for both  
diameter sizes

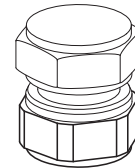

### ADJUSTABLE BRASS RING(S) FLUID LEVEL INDICATORS

- 1RNG = One ring
- 2RNG = Two rings

ADJUSTABLE  
RING  
LOCATION



### SEAL MATERIALS OTHER THAN BUNA N (STANDARD)

- 2BU = Butyl
- 3VI = Viton A®
- 4EP = Ethylene Propylene
- 5SI = Silicone

### SIGHT MATERIALS OTHER THAN GAGE GLASS (STANDARD)

Minimum order quantity may be required

- 1PC = Polycarbonate

### METAL GAGE PARTS OTHER THAN BRASS (STANDARD)

Minimum order quantity may be required

- A = Aluminum

## HOW TO ORDER LDI INDUSTRIES OIL GAGES WITH MODIFICATIONS

Specify the catalog number and pipe thread of the gage required. Then simply choose the modifications you need using the order code shown above, separating each with a dash.

If you need a modification not included above ask us about it! We will be happy to quote from your sketch or specifications.

### EXAMPLE:

**G105-1-A-1PC-3VI** — Viton A® Seals  
 — Polycarb sight  
 — Aluminum construction  
 — 1/8 NPTF threads  
 — Catalog Number G105

Dimensions and specifications are subject to change without notice. Not all items are Made-To-Stock, contact us for availability.

02/14

Ph : 920-682-6877  
 Fx : 920-684-7210



sales@ldi-industries.com  
 www.ldi-industries.com